

Tillykke med dit nye Quadrant system,  
her vil vi guide dig gennem opbygningen af din reol.

Thank you for choosing the Quadrant System.  
Please follow this assembly guide for a smooth and secure assembly.

Wir bedanken uns das Sie System Quadrant Gewählt haben.  
Für einfache Montage, Bitte diese Montage Anleitung folgen.

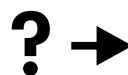

TEL.: + 45 96 64 20 00

EXAMPLES

**A**

Side 2  
Side 2  
Seite 2

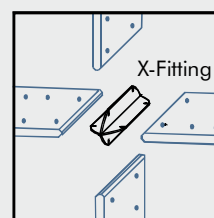
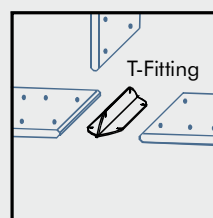
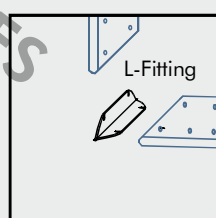
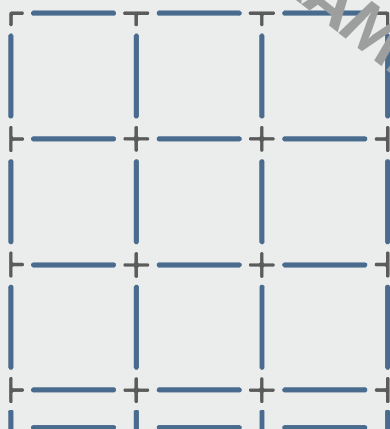

**B**

Side 6  
Side 6  
Seite 6

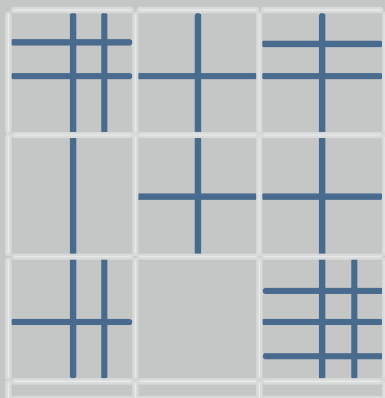

**C**

Side 6  
Side 6  
Seite 6

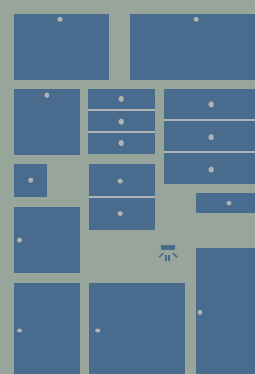
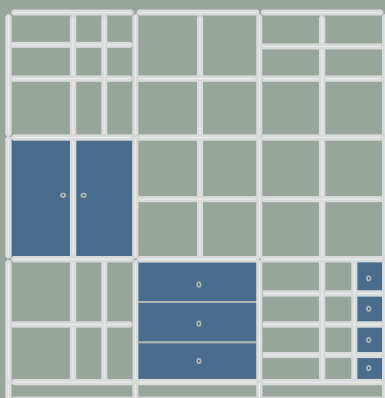

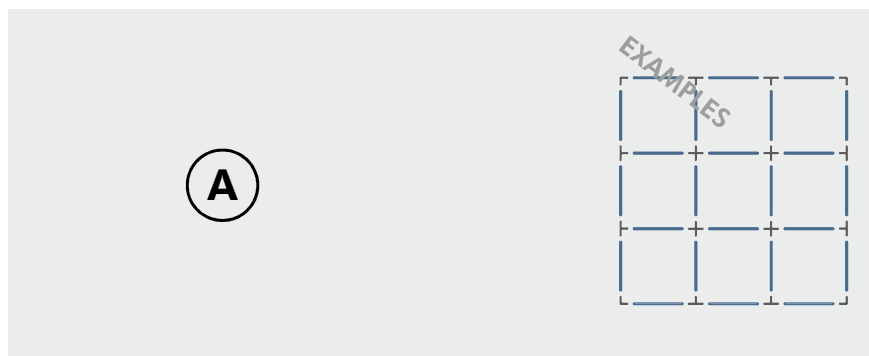
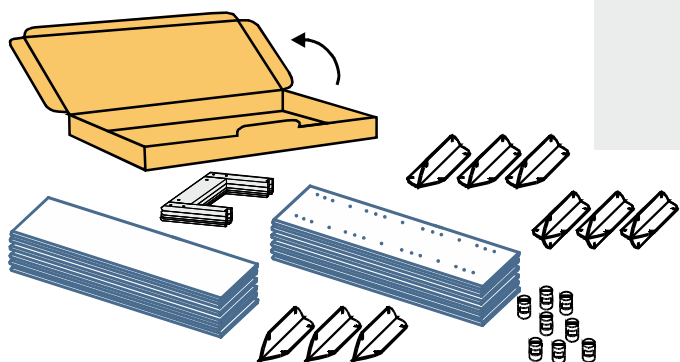

- 1** Pak kasserne med bunde, sider og bagbeklædninger op.  
Sortere efter emner.

Unpack all boxes containing side panels, base panels and backpanels.  
Sort by type.

Bitte alle Paketen mit Seiten und Rückwände Auspacken.  
Seiten nach Typen einteilen.

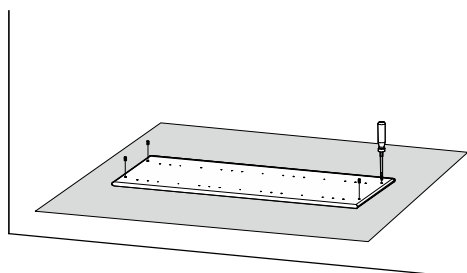

- 2** Monter alle låseskruerne i siderne på et hårdt underlag, der ikke ridser  
- anvend et lag foam fra indpakningen mellem underlag og elementer.

Mount all lock screws in the sides on a hard foundation which does not scratch.  
Use some of the foam as protection on the foundation.

Montieren Sie alle Schliessrauben in die Seiten auf einer festen Unterlage,  
die keine Schrammen machen - bitte verwenden Sie den Filz aus den Verpackungen  
als Unterlage zwischen die Elementen und die Unterlage.

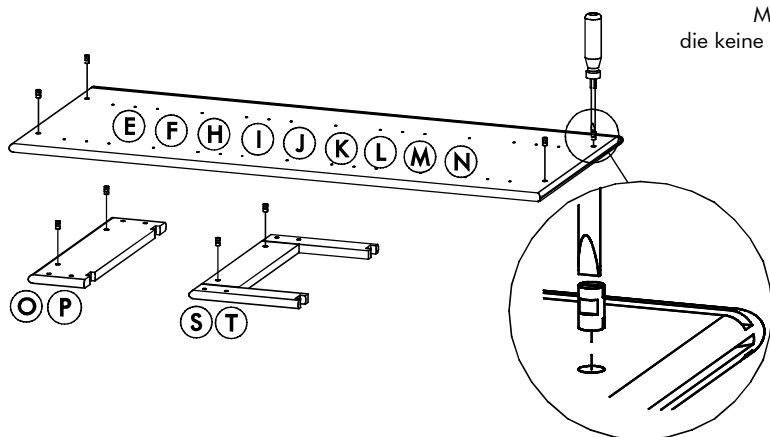

Vigtigt at låseskruerne vender rigtigt

Important lock screws must be in correct position

Wichtig das alle Schliessrauben richtig eingesetzt werden



Side typer  
Page types  
Seitentypen

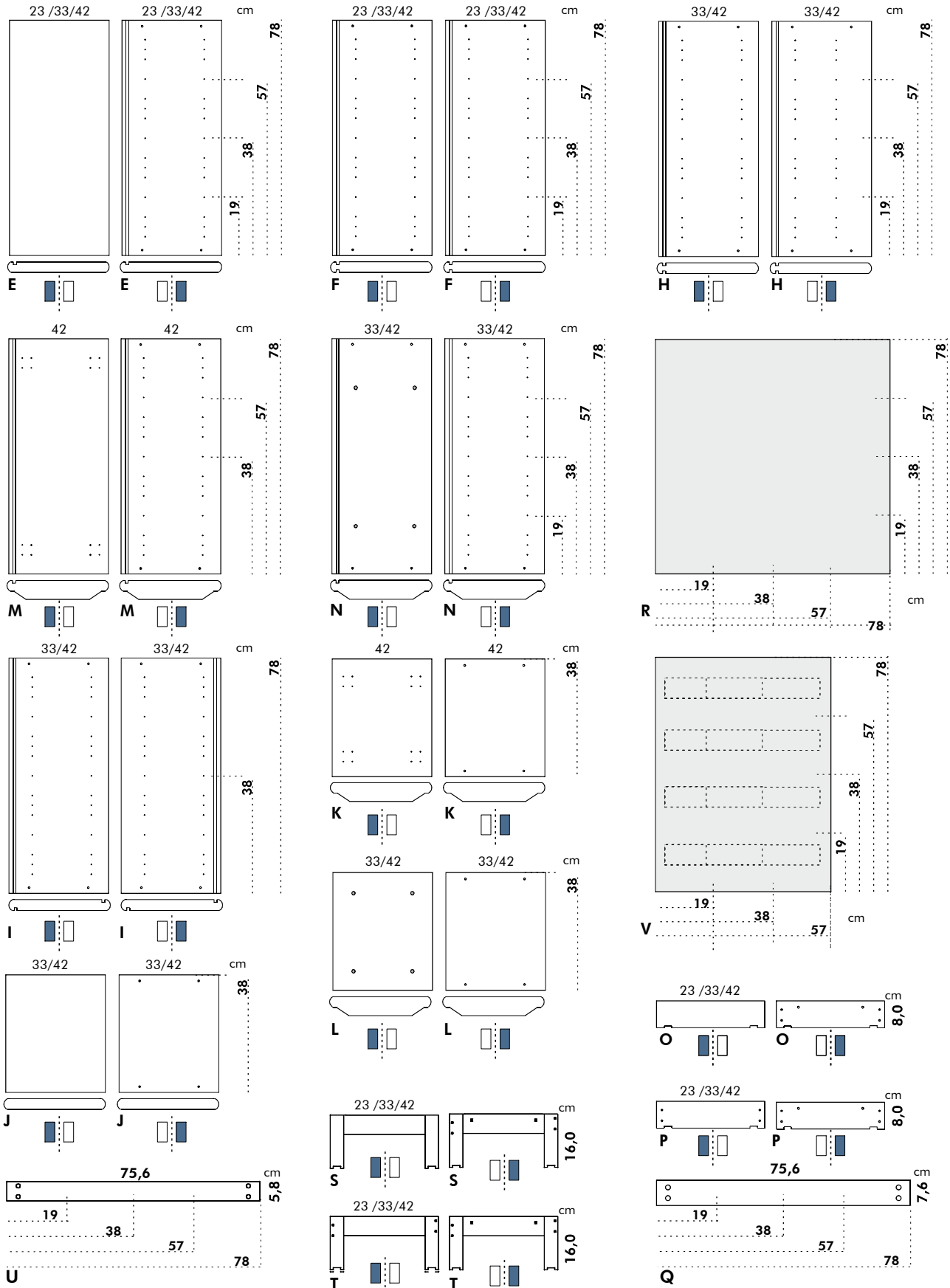

Beslags typer  
Fittings types Beschlag-  
Typen

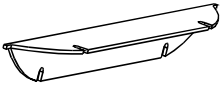

1 L - 23 cm

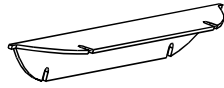

2 L - 33 cm

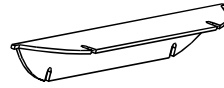

3 L - 42 cm



4 T - 23 cm

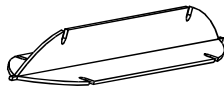

5 T - 33 cm

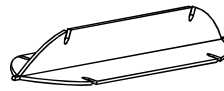

6 T - 42 cm

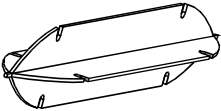

7 X - 23 cm

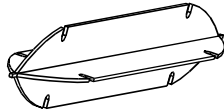

8 X - 33 cm

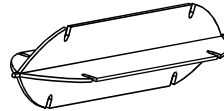

9 X - 42 cm

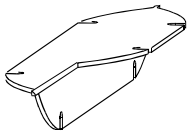

10 T - 23/33 cm

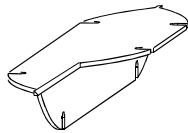

11 T - 33/42 cm

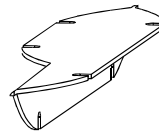

12 T - 23/33 cm

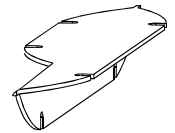

13 T - 33/42 cm

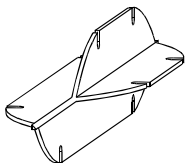

14 X - 23/33 cm

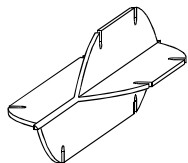

15 X - 33/42 cm

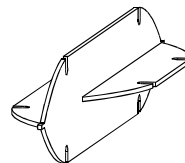

16 X - 23/33 cm

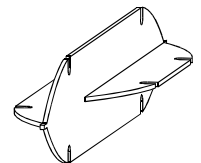

17 X - 33/42 cm

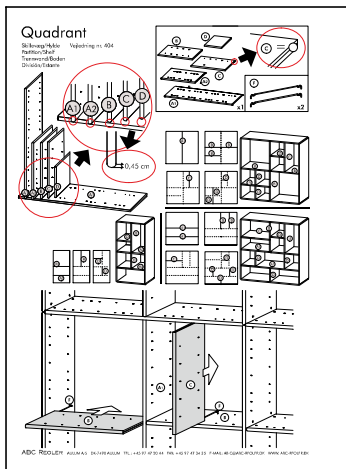
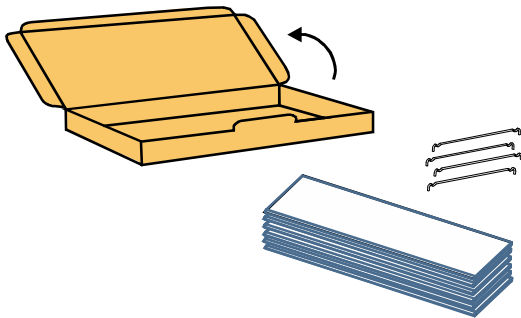

Pak kasserne med skillevægge og hylder op.  
Sortere efter emner og følg de vedlagte samvejledninger.

Unpack all boxes containing Partitions and Shelves.  
Sort by type and follow the assembly instructions included.

Bitte alle Paketen mit Böden und Trennwände auspacken.  
Nach Typen einteilen und Montage Anleitungen folgen.

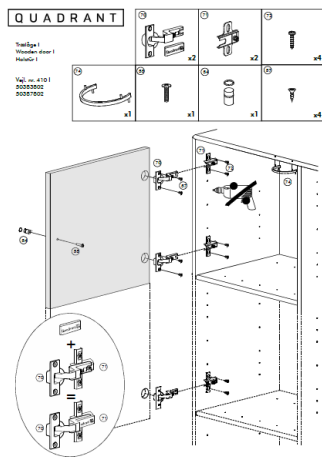
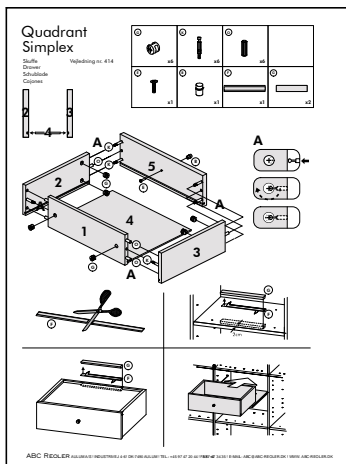
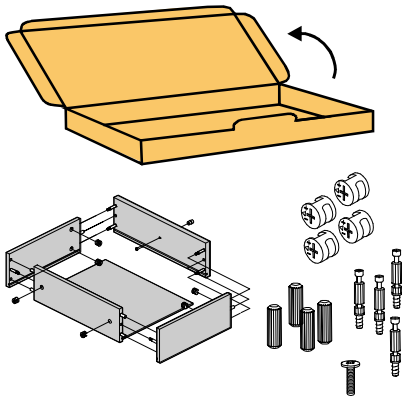

Pak kasserne med indbygningselementer op.  
Sortere efter emner og følg de vedlagte samvejledninger.

Unpack all boxes containing drawers and doors etc.  
Sort by type and follow the assembly instructions included.

Bitte alle Paketen mit Türen und Schubkästen usw. auspacken.  
Nach Typen einteilen und Montage Anleitungen folgen.

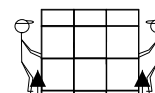

## Flytning af ABC Quadrant

ABC Quadrant kan flyttes samlet. Kontroller at alle låsestifter er låste og afmonter diverse låger, skuffer, hylder og skillevægge. Løft altid fra bunden. Reolen må max. være 240 cm lang ved flytning.

## Moving of the ABC Quadrant Wall System

The ABC Quadrant Wall System can be moved when assembled. Please check that all lock pins are locked, and dismount various doors, drawers, shelves, and partition walls. Please always lift from the bottom. The length of the ABC Quadrant Wall System must be max. 240cm when removed.

## Bewegen des ABC Quadrant

Kann montiert bewegt werden. Kontrollieren Sie, ob alle Sicherungsschrauben befestigt sind, und montieren Sie diverse Türen, Schubladen, Böden und Trennwände. Das Regal darf max 240 cm breit sein.

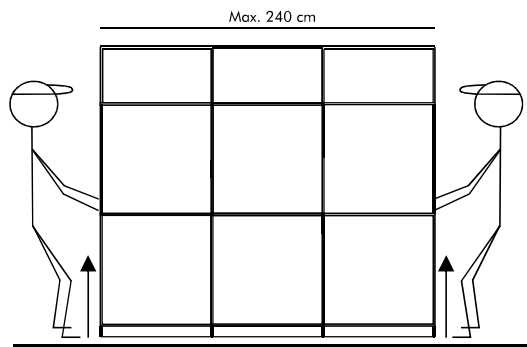
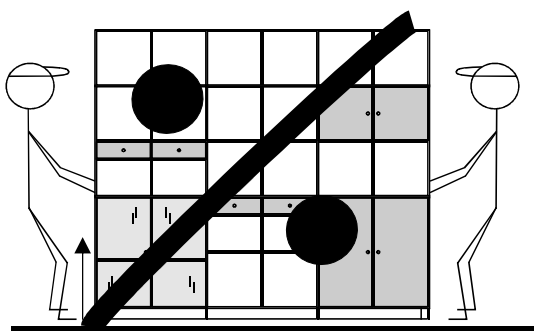

## Belastning

For at garantien gør sig gældende skal visse forhold være varetaget. Alle låsestifter skal være låste. Dette er yderst vigtigt idet låsestiften udgør samlingen. Sider, skillevægge og tilbehør skal monteres efter monteringsvejledningerne.

Quadrant til gulv må ikke belastes med mere end 75 kg. pr. modul - inkl. tilbehør. En hylde må ikke belastes med mere end 10 kg.

## Load

To maintain the guarantee, certain conditions must be observed. All lock pins must be locked. This is extremely important as the lock pin constitutes the assembly. Sides, partition walls, and accessories must be mounted according to the assembly instructions.

Quadrant for the floor must not be loaded with more than 75 kg. per module including accessories. A shelf must not be loaded with more than 10 kg.

## Belastung

Um die Garantie zu gewährleisten, müssen folgende Punkte beachtet werden. Alle Sicherungsschrauben müssen geschlossen sein. Dieser Punkt ist äusserst wichtig, da die Sicherungsschrauben die Stabilität ausmachen. Alle Teile müssen lt. Montageanleitung montiert werden.

Quadrant dürfen jeweils nicht mit mehr als 75 kg. je Module einschl. Schubladen, Boden etc. Ein Boden darf nicht mit mehr als 10 kg. belastet werden.

## Ved udbygning af ABC-Quadrant skal ydersiderne flyttes

## When enlarging the ABC system, move outside panels.

## Bei Erweiterung müssen die Aussenseiten versetzt werden.

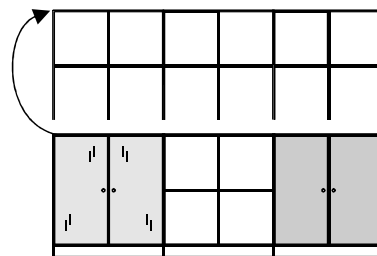
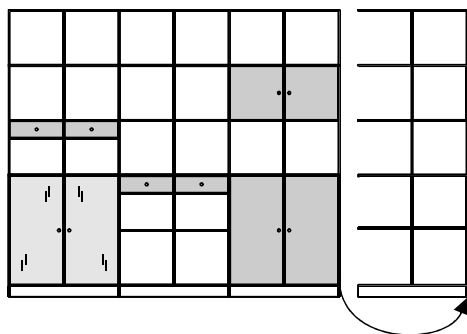

Ved genbestilling tages der forbehold for ændringer i farvenuancer.

When reordering, we reserve our position on changes in colour shades.

Für Farbgleichheit bei Nachbestellungen kann keine Garantie übernommen werden.

# QUADRANT

## GENERAL



Låsevejledning  
Lock direction  
Schliesrichtung



**VIGTIGT** Monter alle låseskruerne i siderne på et hårdt underlag, der ikke ridser - anvend et lag foam fra indpakningen mellem underlag og elementer.

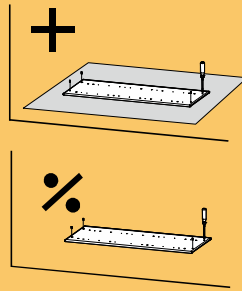

**IMPORTANT** Mount all lock screws in the sides on a hard foundation which does not scratch. Use some of the foam as protection on the foundation.

**WICHTIG** Montieren Sie alle Schliesschrauben in die Seiten auf einer festen die keine Schrammen machen - bitte verwenden Sie den Filz aus den Verpackungen als Unterlage zwischen die Elementen und die Unterlage.

1

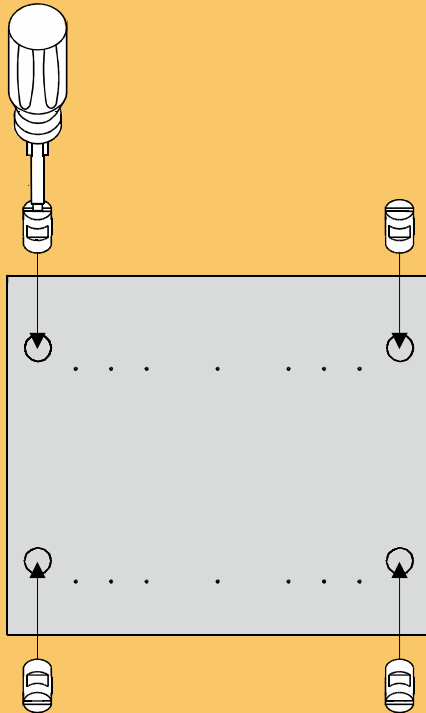

2

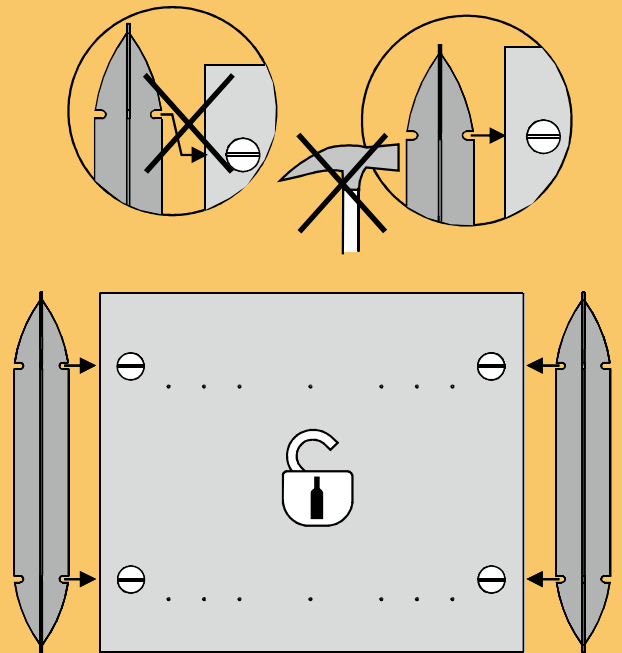

3

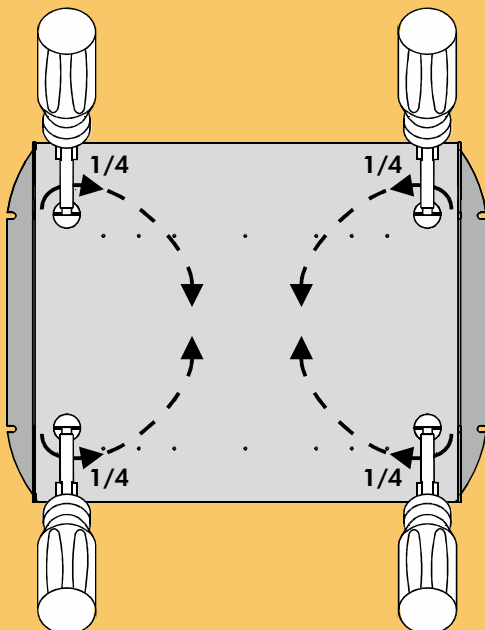

4

